

符合RoHS

ERON® AMF

No.E-9756

PADS FOR SCREW JACKS

千斤顶用附件

材质 S45C

热处理 淬火HRC30±5

表面处理 发黑处理

- 使用时, 请利用千斤顶顶面的孔。
- JAT6440为球面支撑型。
- JAT6441为V型槽支撑型。



JAT6440



JAT6441

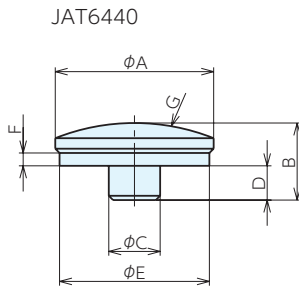

JAT6440

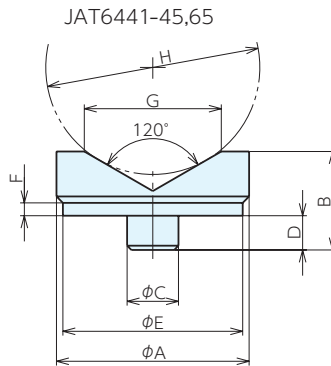

JAT6441-45,65

规格

订单号	型号	A	B	C	D	E	F	G	H	I	重量g
951159	JAT6440	37	18	12	8	35	3	R50	-	-	90
951160	JAT6441-45	45	23	12	8	42	3	32	10- 50	-	120
951161	JAT6441-65	65	38	12	8	62	3	56	22-100	-	545

使用例

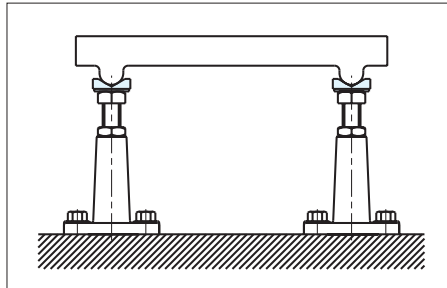
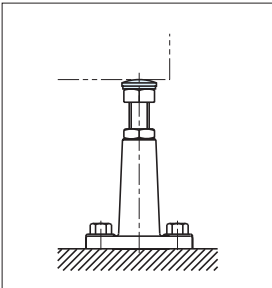

参见页

重型千斤顶



P.530 ▶

千斤顶



P.529 ▶

快速调节千斤顶



P.530 ▶

高度调整螺纹顶



▶

基准台面

辅助台面

精密平口钳

夹具单元

夹持工装零部件

定位元件

装入式零件

隔振及防振

千斤顶

平台、测量仪

钻床平口钳

机工虎钳

索引



JAT6442



JAT6443



JAT6445

符合RoHS

ERON® AMF®

No.E-9756

PADS FOR SCREW JACKS

千斤顶用附件

材质 S45C

热处理 淬火HRC30±5

表面处理 发黑处理

- JAT6442适用于千斤顶(ACS50-100, HCS75-115, HCM85-125)重叠使用的情况。
- JAT6443适用于夹杆的导向。
- JAT6445为球体支撑型。
承重: 30kN

JAT6442

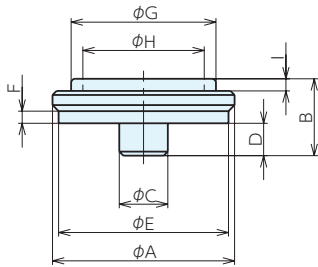

JAT6443-14,25

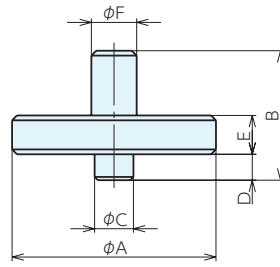

JAT6445

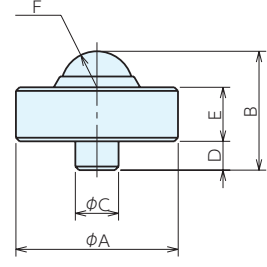

基准台面

辅助台面

精密平口钳

夹具单元

夹持工装零部件

定位元件

装入式零件

隔振及防振

千斤顶

平台、测量仪

钻床平口钳

机工虎钳

索引

规格

订单号	型号	A	B	C	D	E	F	G	H	I	重量g
951162	JAT6442	45	19	12	8	42	3	35.8	30	3	120
951163	JAT6443-14	63	40	12	8	12	14	-	-	-	325
951164	JAT6443-25	78	53	12	8	15	25	-	-	-	715
958028	JAT6445	45	33	12	8	15	R10	-	-	-	240

使用例

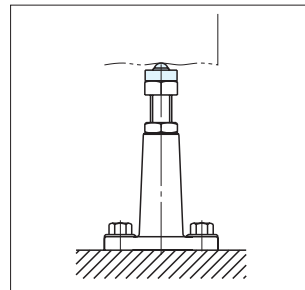
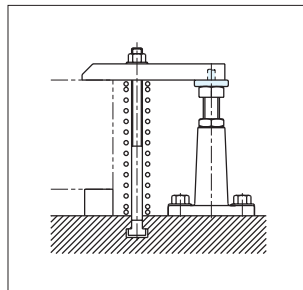
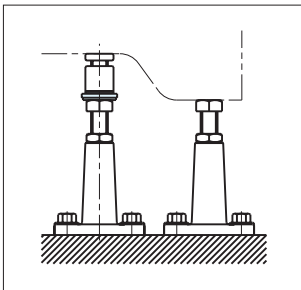

螺纹顶



P.529 ▶

铝底座螺纹顶



P.601 ▶

磁性螺纹顶



P.601 ▶